

EASY CONNECT®

INSTALLATION INSTRUCTIONS

QUESTIONS OR CONCERNS CONTACT AT:
1-800-265-1833 (English) / 1-800-567-2513 (French)
Monday through Friday 8:00 AM to 5:00 PM E.S.T.



SAFETY PRECAUTIONS:

1. TURN OFF ELECTRICAL POWER BEFORE STARTING INSTALLATION OF LIGHT FIXTURE.
2. WIRING SUPPLIES AS REQUIRED BY LOCAL ELECTRICAL CODE.
3. THIS PRODUCT MUST BE INSTALLED IN ACCORDANCE WITH THE APPLICABLE INSTALLATION CODE BY A PERSON FAMILIAR WITH THE CONSTRUCTION AND OPERATION OF THE PRODUCT AND THE HAZARDS INVOLVED.
4. TO CLEAN THE FIXTURE, TURN OFF THE POWER, WAIT FOR IT TO COOL, AND WIPE THE FIXTURE WITH A CLEAN, SOFT CLOTH.

NOTE: Product may not look exactly as shown in figures.

INSTALLATION:

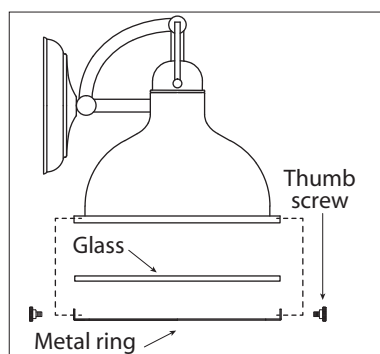

1. Unscrew the 3 thumb screws to remove the glass and metal ring.

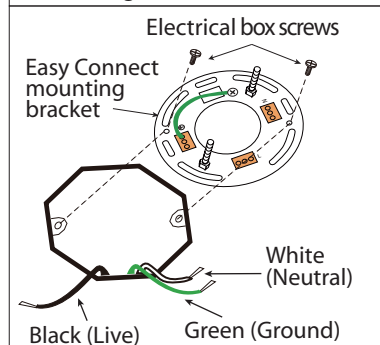

2. Attach easy connect mounting bracket to electrical box with electrical box screws (not included).

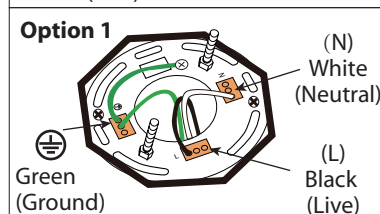

3. **Option 1:** Connect (push) electrical wires from electric box (house wiring) into correct inserts.

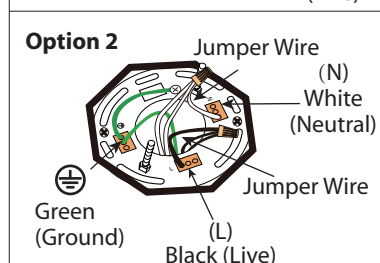

3. **Option 2:** For multiple black (live) & white (neutral) wires joined in the electrical box (house wiring), attach a single "black" and "white" Jumper Wire before connecting. Strip 7mm from a 6" Jumper Wires (AWG 12-24) supplied. Then connect (push) wires into correct inserts.

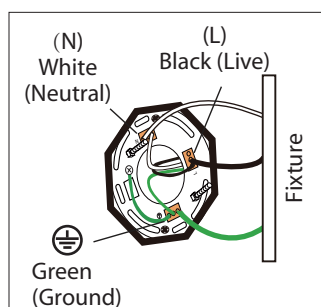

4. Connect (push) electrical wires from fixture into correct inserts.

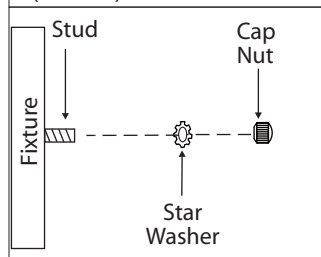

5. Tuck electrical wires into electrical box and position fixture over studs on mounting bracket assembly. Secure fixture in place with star washers and cap nuts.

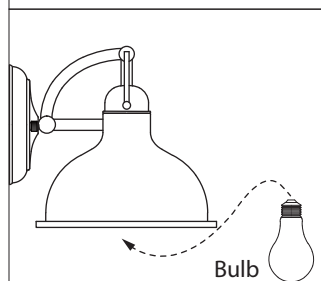

6. Install proper bulb type and wattage (not included).

7. Reverse the process of step #1 to install the fixture.

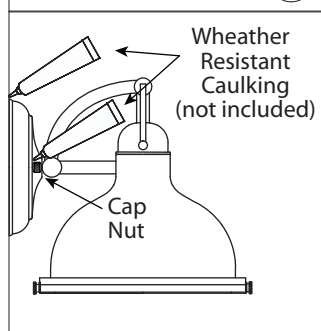

8. After installation, seal around the top and side perimeter between the fixture and the wall surface with weather resistant caulking. The bottom should be left un-caulked to prevent moisture build-up. Apply a small amount of weather resistant caulking around the side perimeter between the cap nut and mounting plate.